



DE^SING 德芯科技

----*Giving your digital business a different idea*







About Us



Solution

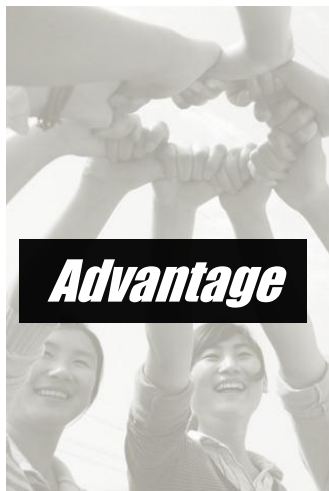

Advantage



Support



Culture



Dexin, founded in 1994, is one of the leading Digital TV head-end Solution designers and manufacturers with 22 years history in Chengdu, China. Dexin now owns 60 million registered capitals and has a whole 15,893 m² building place.



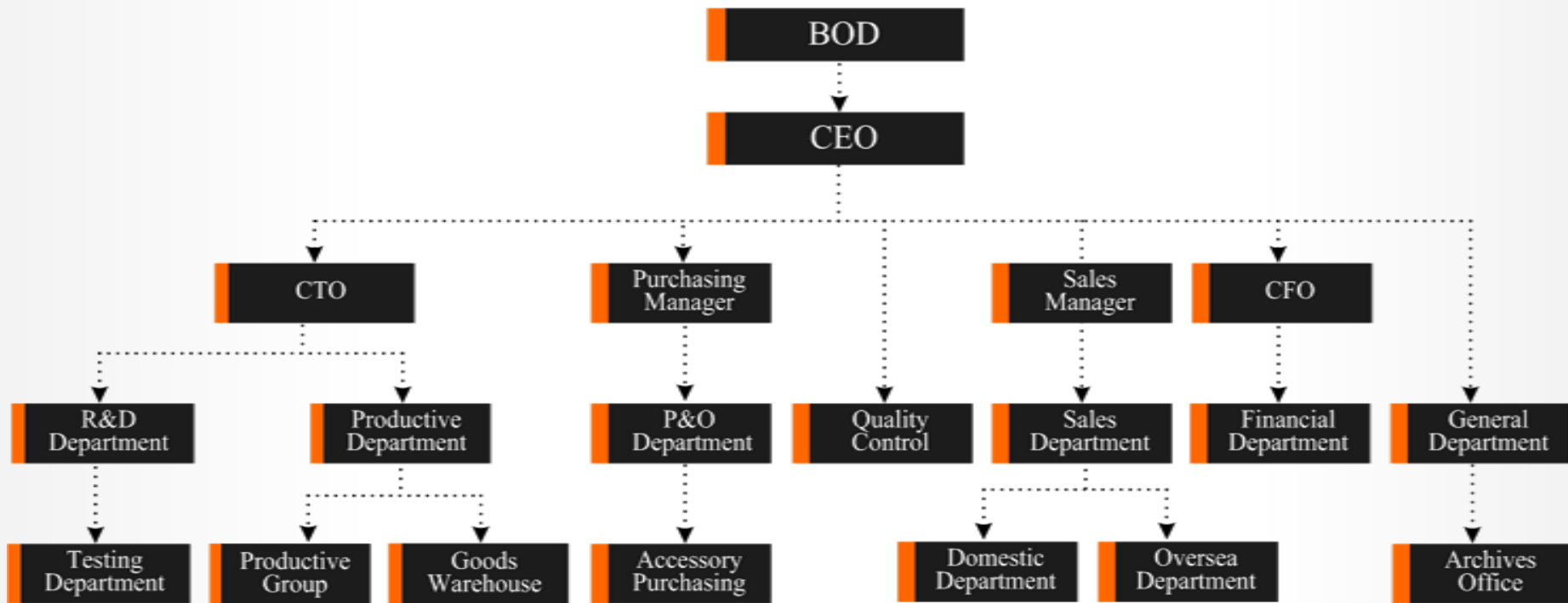

History

WE GROW RECORDS

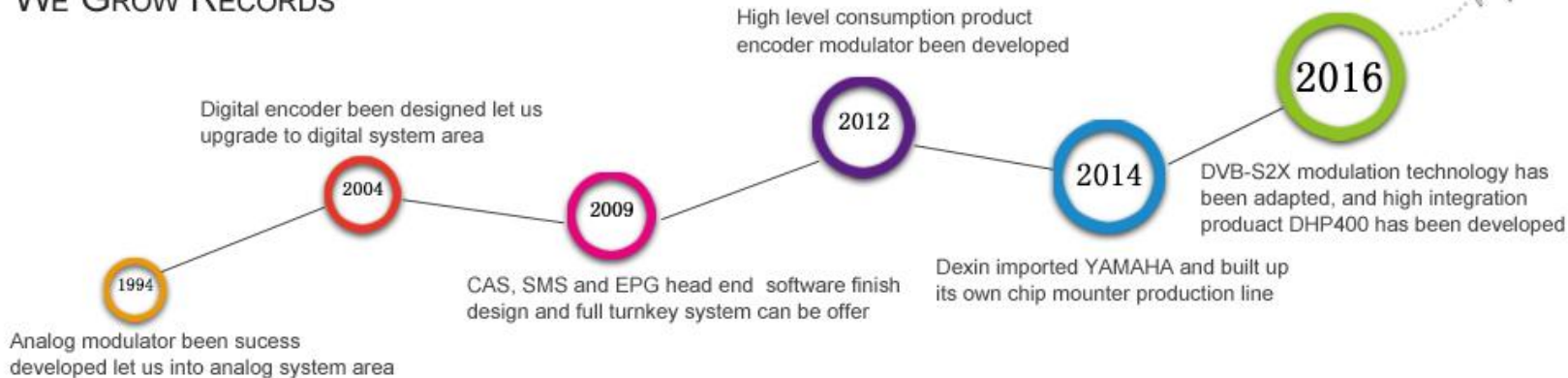

Million (USD)

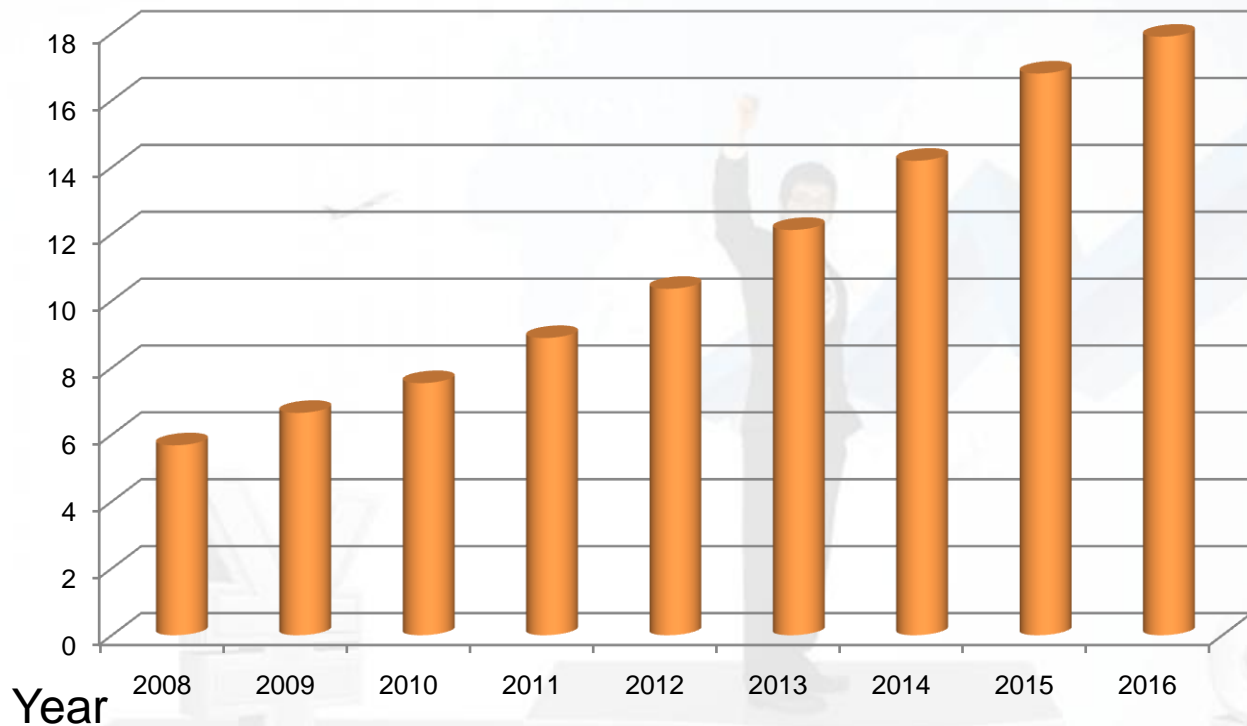



5 branch office

30 elite sales team

23 agency channel

500 successful case





Our customers have widely covered most region of North America and Western Europe, South America, Eastern Europe, South East Asia, Africa, Oceania, Mideast, Eastern Asia etc.



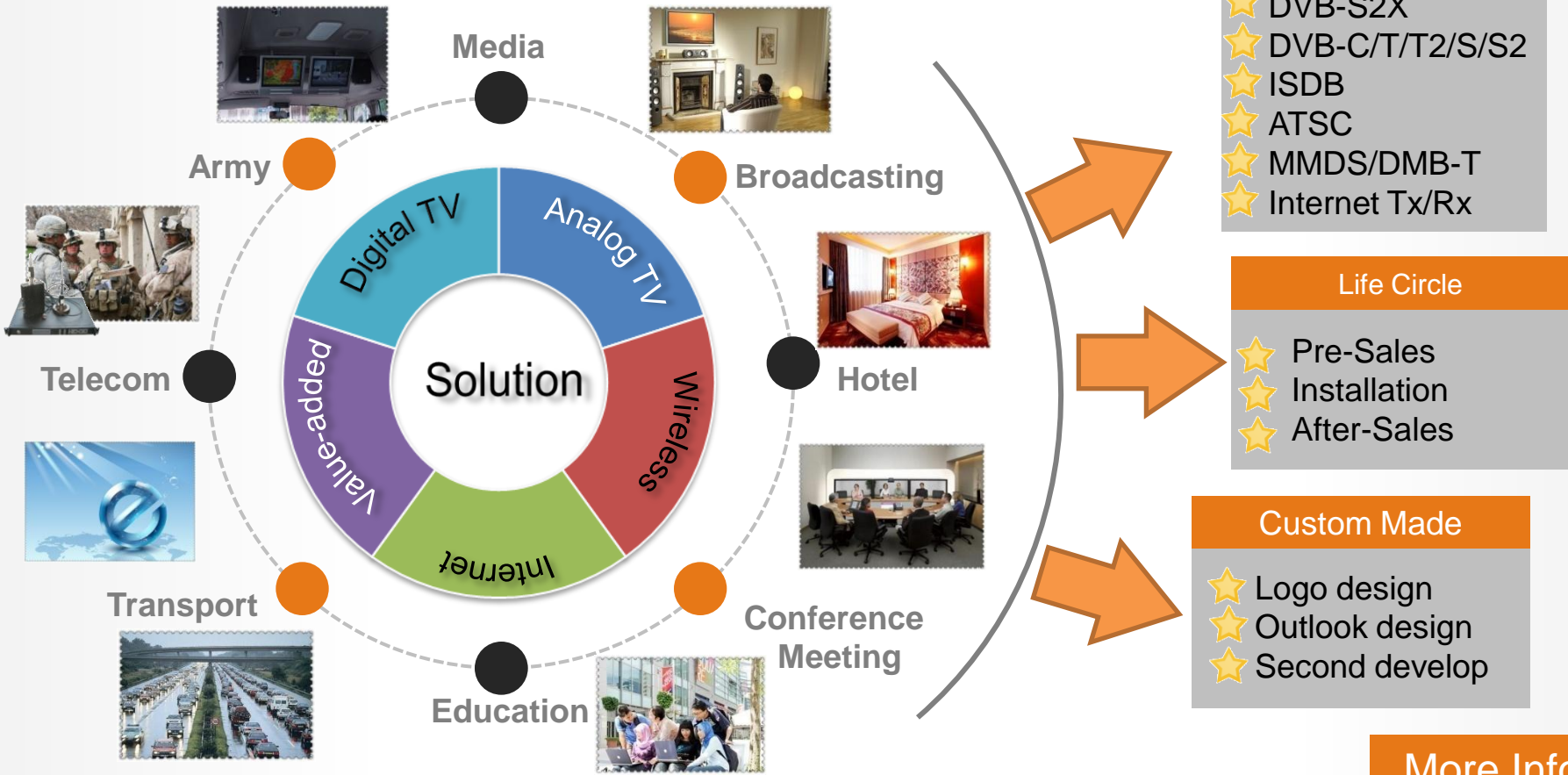

More Info →





 **CCBN**



 **IBC**



 **CSTB**



 **Connect**



 **NAB**



 **Anga**



 **B&C**



 **CABSAT**

[Latest Info →](#)



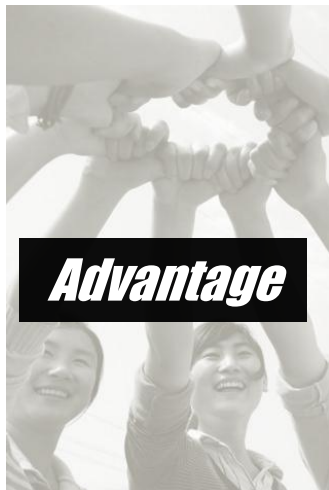

Dexin Digital Headend DVB-C Solution

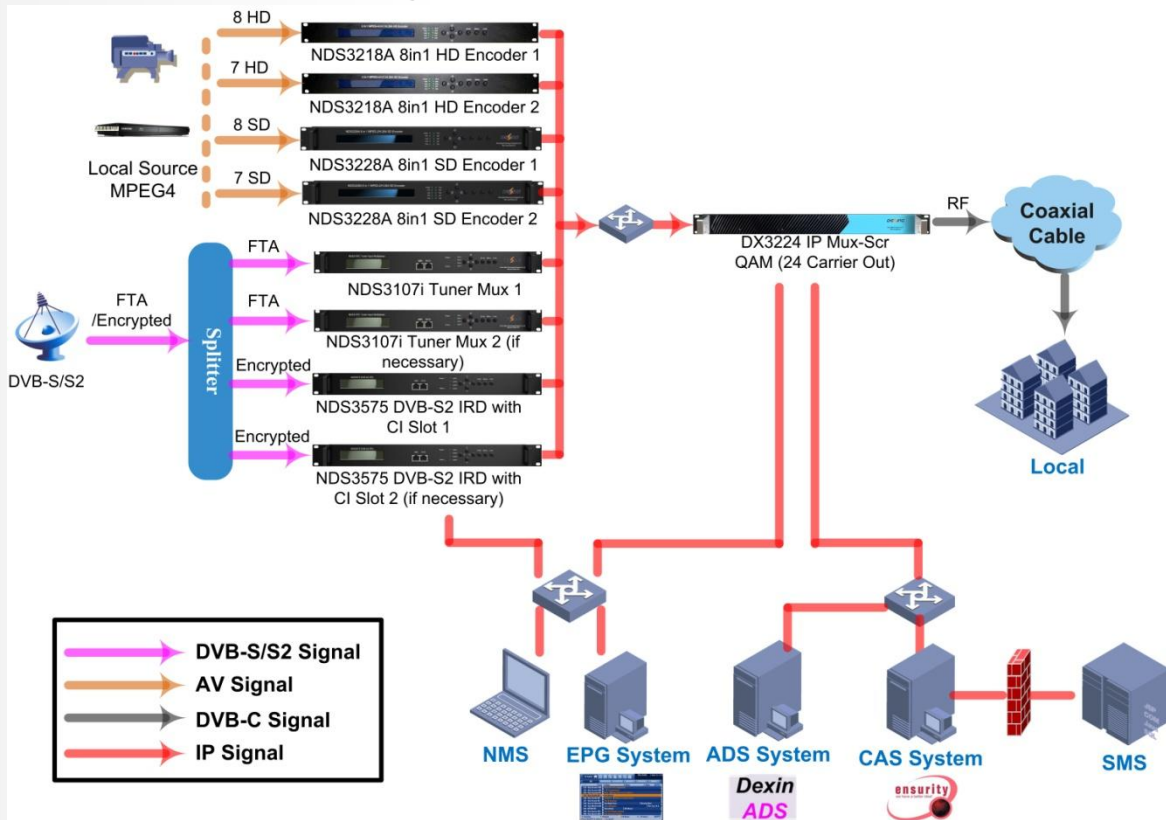

Solution Benefit

- More flexible and stable
- Easy to management
- Integrated and cost-effective

Key Device involved 

NDS3228A 8in1 Encoder

- Input: 8x CVBS
- Output: 1x ASI, IP
- Encoding: MPEG2, H.264

NDS3107I Tuner Mux

- Input: 6x DVB-S/S2, 2x ASI
- Output: 2x ASI, IP
- Inner: multiplexing

DX3224 IP QAM

- Input: 2512x3 IP per card
- Output: 8x3 RF&IP
- Inner: multiplexing, SCR QAM modulation

More Info →



Dexin Digital Headend DVB-T/T2 Solution

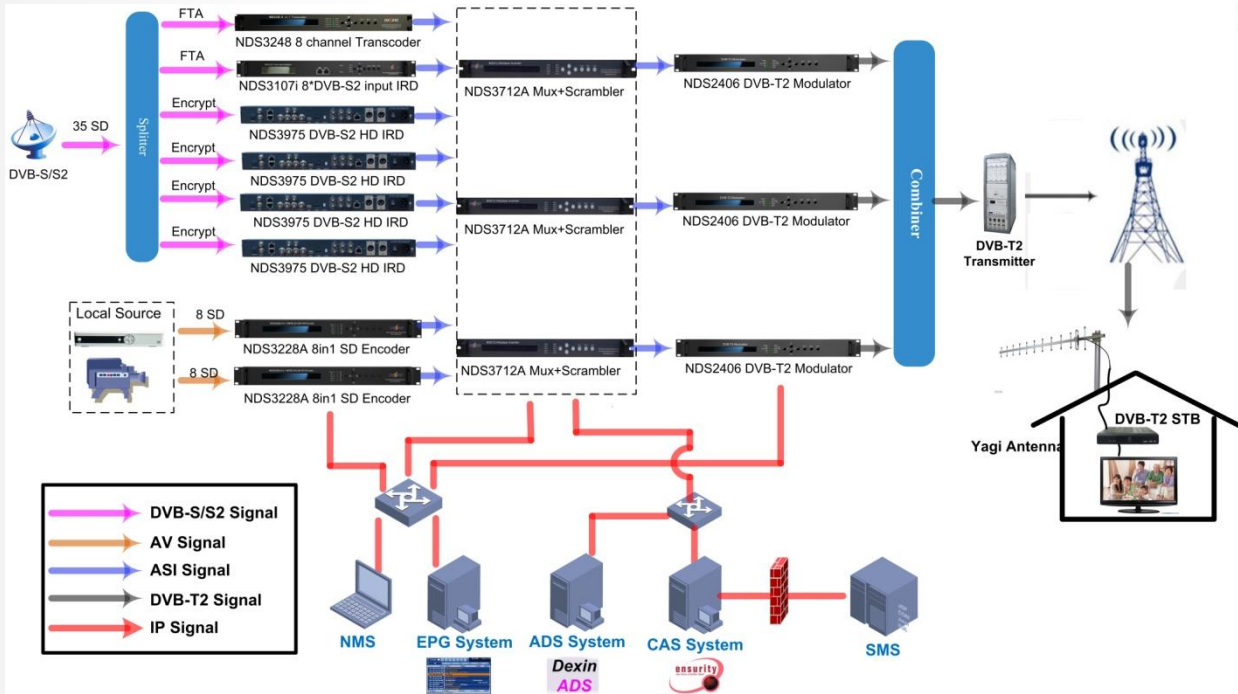

Key Device Involved



- Input: 8xIP, 6xTuner
- Output: 1xASI, IP
- 8 SD or 4 HD programs
- trans-coding

NDS3248 8in1 Transcoder



- Input: 8XASI
- Output: 2XASI
- SCR: Scrambling

NDS3712A Mux with SCR



- Input: ASI, 10Mhz, 1PPS
- Output: DVB-T2 RF
- Other: Support DPD

NDS2406 DVB-T2 Modulator



- Input: RF, Fiber
- Output: RF
- Power: 1W-600W

DVB-T2 Transmitter

More Info →



DVB-S2 System ASI Based Solution

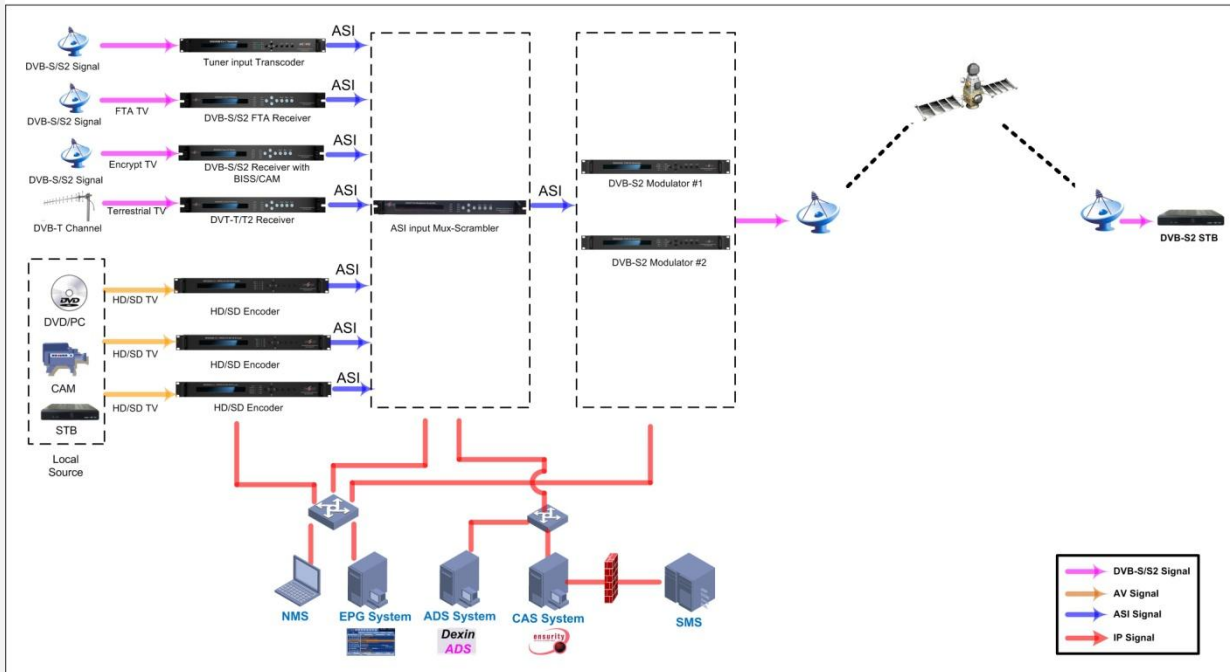

Key Device involved

NDS3248B
8in1 Transcoder

- Input: 4xASI, 4xTuner
- Output: 1xASI, IP
- 8 SD or 4 HD programs
- trans-coding

NDS3712A
Mux with SCR

- Input: 8XASI
- Output: 2XASI
- SCR: Scrambling

NDS3228A 8in1 Encoder

- Input: 8XCVBS, 1ASI
- Output: 2xASI, IP
- Encoding: MPEG2, H.264

NDS3402E
DVB-S2 Modulator

- Input: ASI, IP, 10Mhz
- Output: DVB-S/S2 RF
- Other: Support Biss

[More Info](#) →



Dexin Digital Headend MMDS Solution

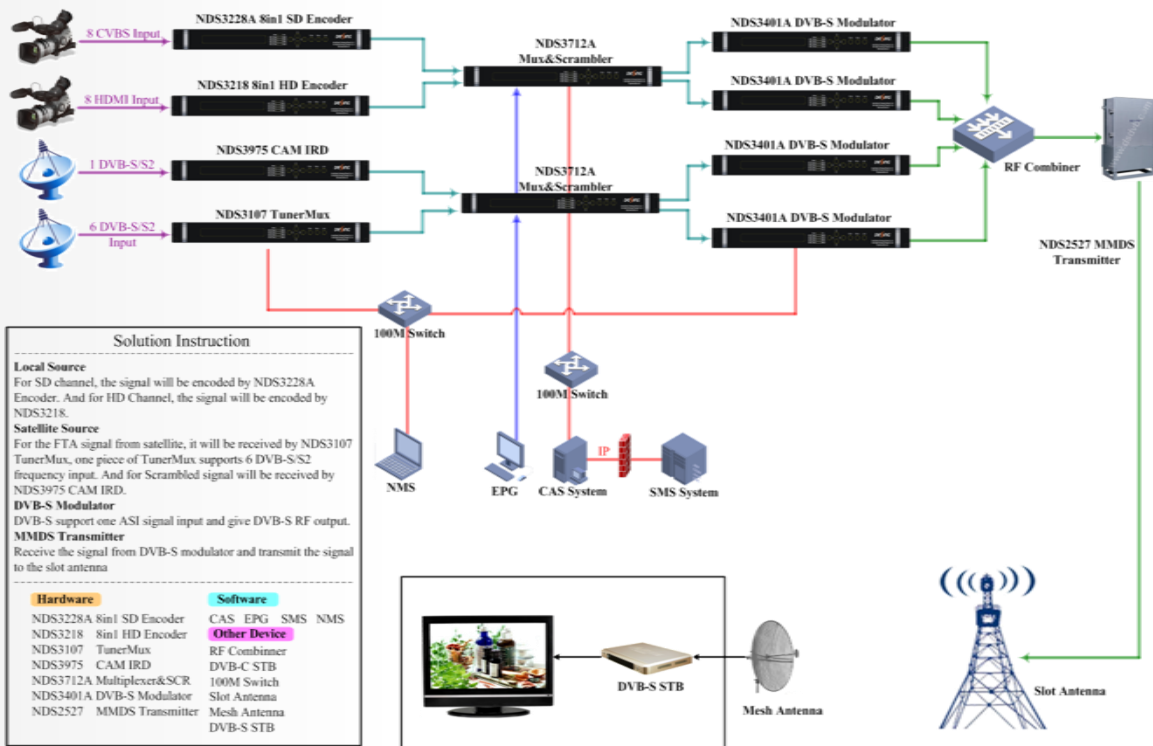

Solution Instruction

Local Source
For SD channel, the signal will be encoded by NDS3228A Encoder. And for HD Channel, the signal will be encoded by NDS3218.

Satellite Source
For the FTA signal from satellite, it will be received by NDS3107 TunerMux, one piece of TunerMux supports 6 DVB-S/S2 frequency input. And for Scrambled signal will be received by NDS3975 CAM IRD.

DVB-S Modulator
DVB-S support one ASI signal input and give DVB-S RF output.

MMDS Transmitter
Receive the signal from DVB-S modulator and transmit the signal to the slot antenna

Hardware	Software
NDS3228A 8in1 SD Encoder	CAS EPG SMS NMS
NDS3218 8in1 HD Encoder	Other Device
NDS3107 TunerMux	RF Combiner
NDS3975 CAM IRD	DVB-C STB
NDS3712A Multiplexer&SCR	100M Switch
NDS3401A DVB-S Modulator	Slot Antenna
NDS2527 MMDS Transmitter	Mesh Antenna
	DVB-S STB

Key Device involved

- Input: 8XCVBS, 1ASI
- Output: 2xASI, IP
- Encoding: MPEG2, H.264

- Input: 8XASI
- Output: 2XASI
- SCR: Scrambling

- Input: ASI, 10Mhz
- Output: DVB-S RF
- Other: NMS control

- Input: RF, Fiber
- Output: RF
- Power: 1W-200W

More Info →



Hotel, supermarket, Bar Audio-Video contents distribution

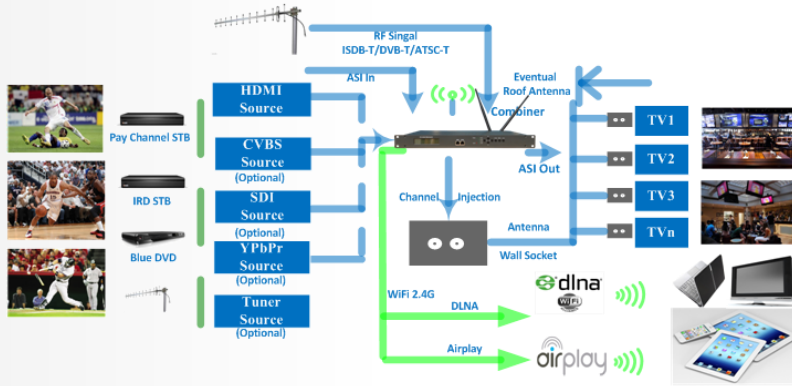

Internet Video & Audio transmission solution

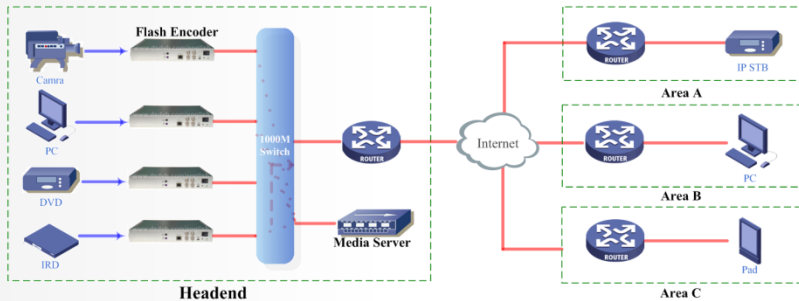

Mobile transmitting solution

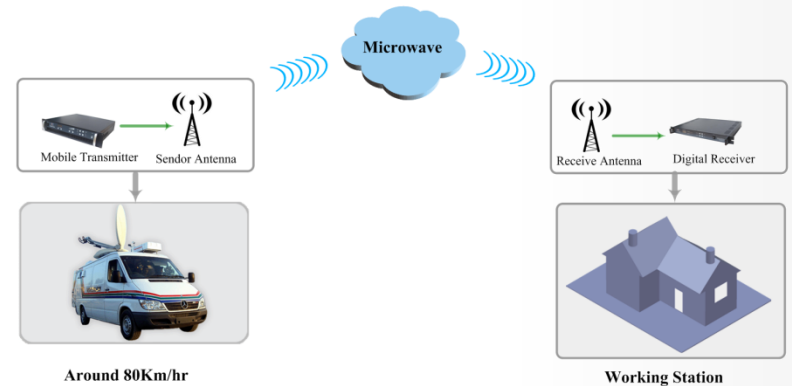

More Info →





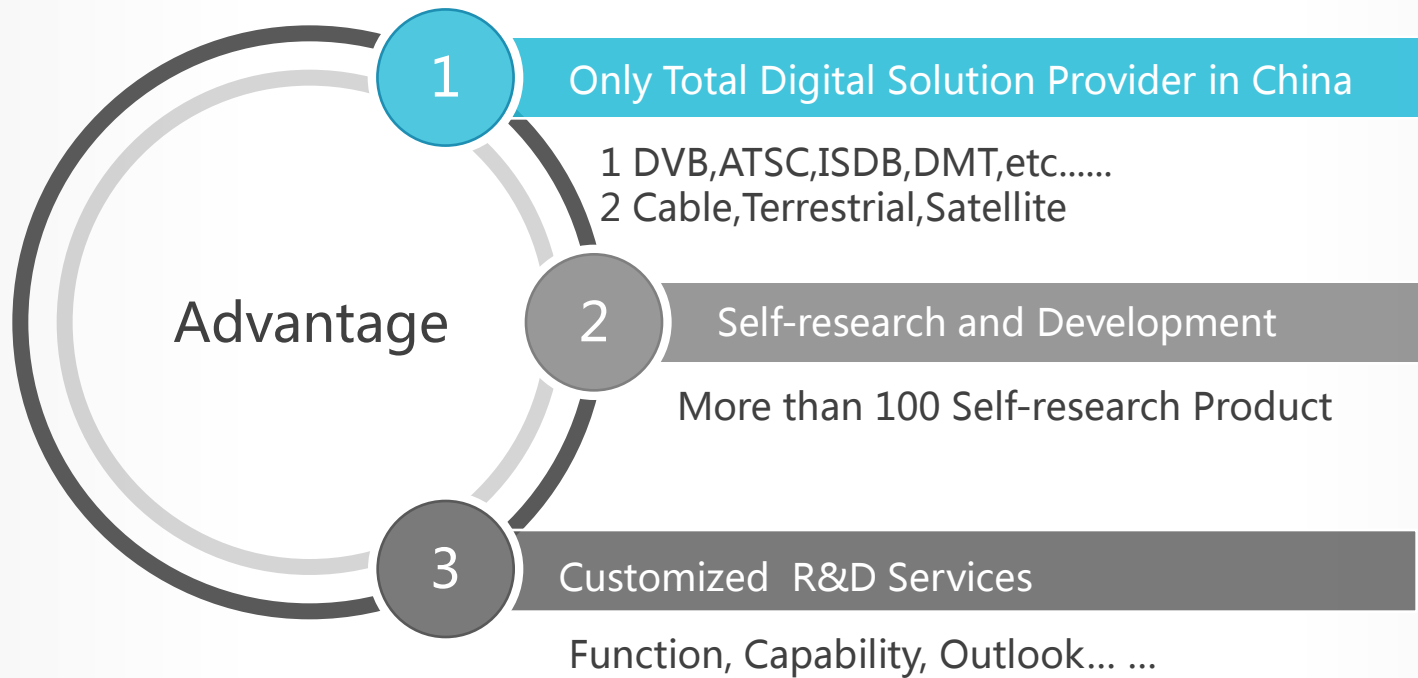



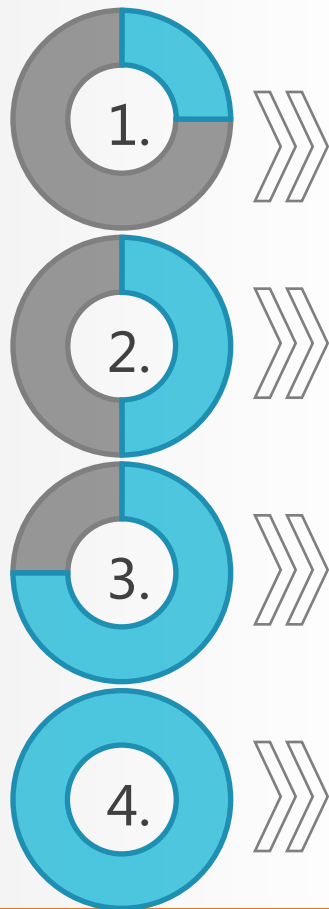

Digital Product

<p>Software Series CAS EPG SMS Value-Added</p>	<p>Hardware Series Slot device Series Encoder/IRD/QAM Series</p>
---	---

Wireless Product

<p>MMDS Transmitter Portable Transmitter</p>	<p>Wi-Fi Encoder Modulator DLNA/Airplay Convertor</p>
--	---

Analog Product

<p>4in1 Modulator RF Combiner</p>	<p>Adjustable Modulator AV splitter</p>
---------------------------------------	---

Other Product

<p>Flash Encoder HTTP Encoder</p>	<p>TS Analyzer Flash Encoder</p>	<p>Optical Tx/Rx</p>
---------------------------------------	--	--------------------------------

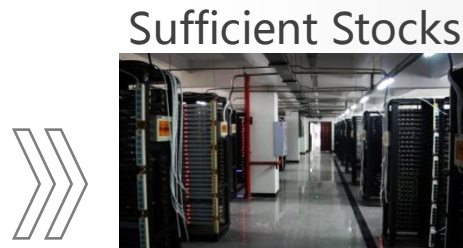



Training Item

- 1 Basic digital knowledge training
- 2 Device application training
- 3 System installation training
- 4 Daily maintenance training

Technical Service

- 1 Remote updating
- 2 Remote installation
- 3 Remote debug
- 4 On site installation
- 5 On site trouble shooting

Service Policy

- 1 7X24 technical Service
- 2 On site/ Remote/ Phone call







*A world-class supplier
for digital TV*



*Internationalization,
Professionalization,
Branding*

Culture



*Honest ,reliant
honorific ,laborious*



*Growing with customers ,
Growing with staff
Growing with society*



Spirit

- Respect the intellectuals
- Create cultural atmosphere
- Always keep the sense of social responsibility

Service

- Modest and prudent service attitude
- Pragmatic and innovative service spirit
- Professional and competent service team
- Penetrating and acute service awareness

Aspire

- Pursuing the maximization interest of customers
- Pursuing superior services
- Pursuing sustained development
- Pursuing people oriented way to survive

Thanks



Dexin Digital Technology Corp. Ltd.

Add: No.10 and NO.12 Wuxing Fourth Road, Wuhou District,
Chengdu, Sichuan, P.R.China

Tel : 028-85550524

Fax : 028-85585255

Web: www.dsdtvb.com/english

DE^SING 德芯科技
---Giving your digital business a different idea

